

UHF-Band RF Power MOSFET

The high power transistor part number IDM500CW300 is designed for VHF/UHF-Band systems operating at 1-500 MHz. Operating at CW conditions, this dual MOSFET device supplies a minimum of 300 watts of power across the instantaneous operating bandwidth of 1-500 MHz. All devices are 100% screened for large signal RF parameters.

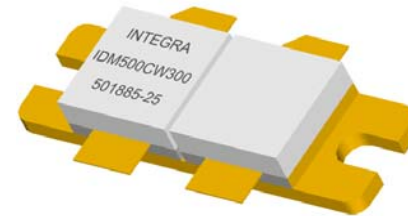

Silicon MOSFET

- High Power Gain
- Superior thermal stability

Class AB Operation

- Gate biased to $I_{DQ}=2x100mA$

Configuration

- Common Source

Gold Metal

- Maximum Reliability

BeO Package

- High Temperature Braze Package to Flange Attachment
- Unmatched Thermal Reliability

Epoxy Sealed Lid

- Gross Leak Qualified

RF Test Fixture

- Narrowband
- Matched to 50Ω
- Long-term Correlation
- 100% Device RF Screening
- No External Tuning required

TYPICAL DATA TYPICAL DATA TYPICAL DATA TYPICAL DATA

| Device | Freq (MHz) | V _{DD} (V) | P _{IN} (W) | IRL (dB) | P _{OUT} (W) | Gain (dB) | I _D (A) | η _d (%) |
|---------|------------|---------------------|---------------------|----------|----------------------|-----------|--------------------|--------------------|
| D5228-1 | 200 | 28 | 9.9 | 10 | 330 | 15.2 | 18.1 | 65.2 |
| D5228-1 | 300 | 28 | | | | | | |
| D5228-1 | 400 | 28 | 37.4 | 20 | 330 | 9.46 | 16.9 | 69.8 |
| D5228-1 | 500 | 28 | | | | | | |

MAXIMUM RATINGS

| Screen | Parameter | Symbol | Min | Max | Units | Test Conditions |
|--------|--|-----------|-----|------|-------|-----------------|
| BD | Drain-Source Voltage | V_{DS} | -- | 80 | V | -- |
| BD | Gate-Source Voltage | V_{GS} | -- | 20 | V | -- |
| BD | Storage Temperature Range | T_{STG} | -65 | +150 | °C | -- |
| BD | Operating Junction Temperature Range | T_J | -55 | +200 | °C | -- |
| Note | Screen 'BD' = parameter qualified By Design. | | | | | |

THERMAL CHARACTERISTICS

| Screen | Parameter | Symbol | Min | Max | Units | Test Conditions |
|--------|--|--------------|-----|------|-------|--|
| BD | Thermal Resistance | $R_{TH(JC)}$ | -- | 0.36 | °C/W | $V_{CC}=28V, I_{DQ}=2x100mA, T_F=25\pm5^\circ C, P_{OUT}=300W$ |
| Note | Screen 'BD' = parameter qualified By Design. | | | | | |

PROCESSING SPECIFICATIONS

| Screen | Parameter | Symbol | Min | Max | Units | Test Conditions |
|--------|--|--------|-----|-----|-------|---|
| 100% | DC Wafer Probe | -- | -- | -- | -- | Per Integra specification. |
| Q1 | Wafer DC and RF Qualification | -- | -- | -- | -- | Per Integra specification. |
| LM | Wire Bond Strength | -- | -- | -- | -- | Line monitor per Integra specification. |
| 100% | Pre-cap visual inspection | -- | -- | -- | -- | Per Integra specification |
| 100% | Gross leak test | -- | -- | -- | -- | MIL-STD-750D, Method 1071, Test Condition C |
| Note | Screen 'Q1' = parameter is qualified by assembly and test of 3 pieces minimum per wafer. | | | | | |
| Note | Screen 'LM' = parameter is qualified by assembly line monitor. | | | | | |

DC ELECTRICAL CHARACTERISTICS

| Screen | Parameter | Symbol | Min | Max | Units | Test Conditions |
|--------|--------------------------------------|-------------|-----|-----|---------|---|
| 100% | Drain-Source Breakdown Voltage | BV_{DSS} | 70 | 100 | V | $I_D = 40mA, V_{GS} = 0V, T_F = 25\pm5^\circ C$ |
| 100% | Drain Leakage Current (each side) | I_{DSS} | -- | 5 | μA | $V_{DS} = 30V, V_{GS} = 0V, T_F = 25\pm5^\circ C$ |
| 100% | Gate Threshold Voltage 1 (each side) | V_{GSTH2} | 1.0 | -- | V | $I_D = 100mA, V_{GS} = 5V, T_F = 25\pm5^\circ C$ |

RF ELECTRICAL CHARACTERISTICS

| Screen | Parameter | Symbol | Min | Max | Units | Test Conditions |
|--------|---------------------------------------|-----------|-----|-----|-------|--|
| 100% | Input Return Loss | RL | 10 | -- | dB | $V_{DD}=28V, I_{DQ}=2x100mA, T_F=25\pm5^\circ C, P_{IN}=37.4W, F=400MHz$ |
| 100% | Output Power | P_O | 300 | -- | W | $V_{DD}=28V, I_{DQ}=2x100mA, T_F=25\pm5^\circ C, P_{IN}=37.4W, F=400MHz$ |
| 100% | Drain Efficiency ($P_O/I_D/V_{DD}$) | N_D | 50 | -- | % | $V_{DD}=28V, I_{DQ}=2x100mA, T_F=25\pm5^\circ C, P_{IN}=37.4W, F=400MHz$ |
| 100% | Gain | G | 9 | -- | dB | $V_{DD}=28V, I_{DQ}=2x100mA, T_F=25\pm5^\circ C, P_{IN}=37.4W, F=400MHz$ |
| BD | Input Capacitance | C_{ISS} | -- | 320 | pF | $V_{DD}=28V, V_{GS}=0V, F=1MHz$ |
| BD | Output Capacitance | C_{OSS} | -- | 160 | pF | $V_{DD}=28V, V_{GS}=0V, F=1MHz$ |
| BD | Reverse Transfer Capacitance | C_{RSS} | -- | 19 | pF | $V_{DD}=28V, V_{GS}=0V, F=1MHz$ |
| Note 2 | T_F = Device flange temperature. | | | | | |

RF TEST FIXTURE IMPEDANCE CHARACTERISTICS

| Frequency (MHz) | Z_{IF} (Ω) | Z_{OF} (Ω) |
|----------------------|-----------------------|-----------------------|
| 200 | 3.60+j3.94 | 6.66-j0.18 |
| 300 | | |
| 400 | 0.96-j1.90 | 2.74-j2.12 |
| 500 | | |
| Impedance Definition | | |

Note : Input and output impedances are measured from gate to gate and drain to drain respectively.

RF Test Data (V_{dd}=28 V, I_{dq}=200 mA)

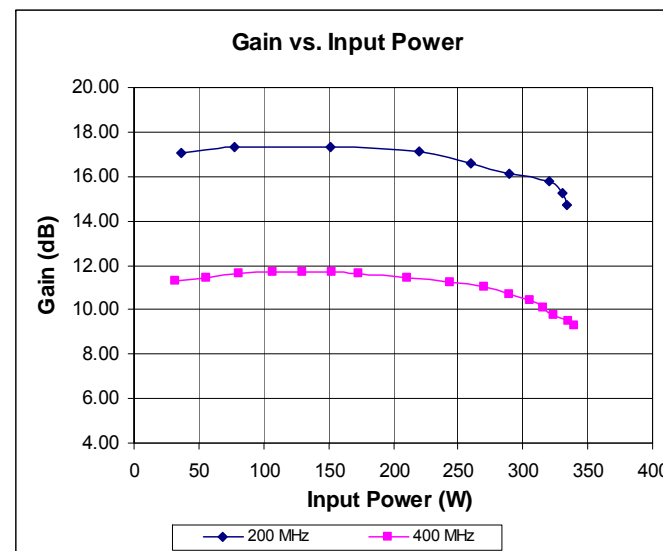
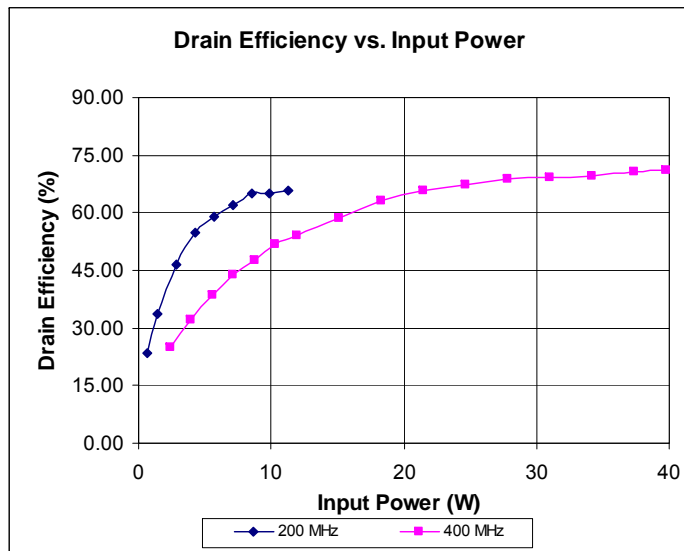
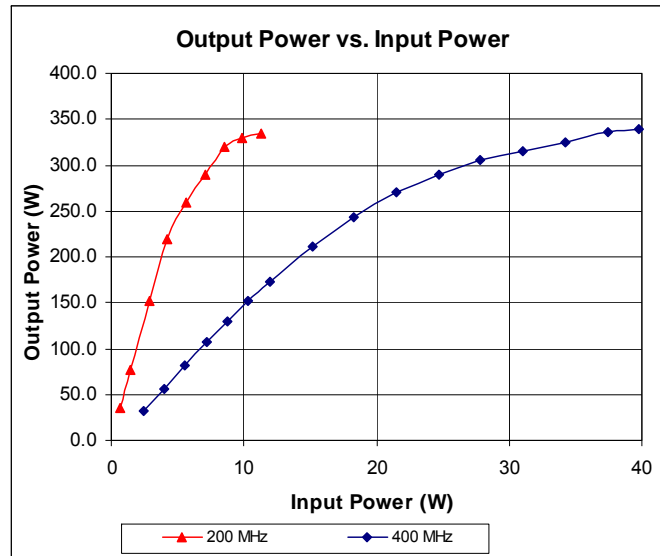

PACKAGE DIMENSIONAL OUTLINE DRAWING

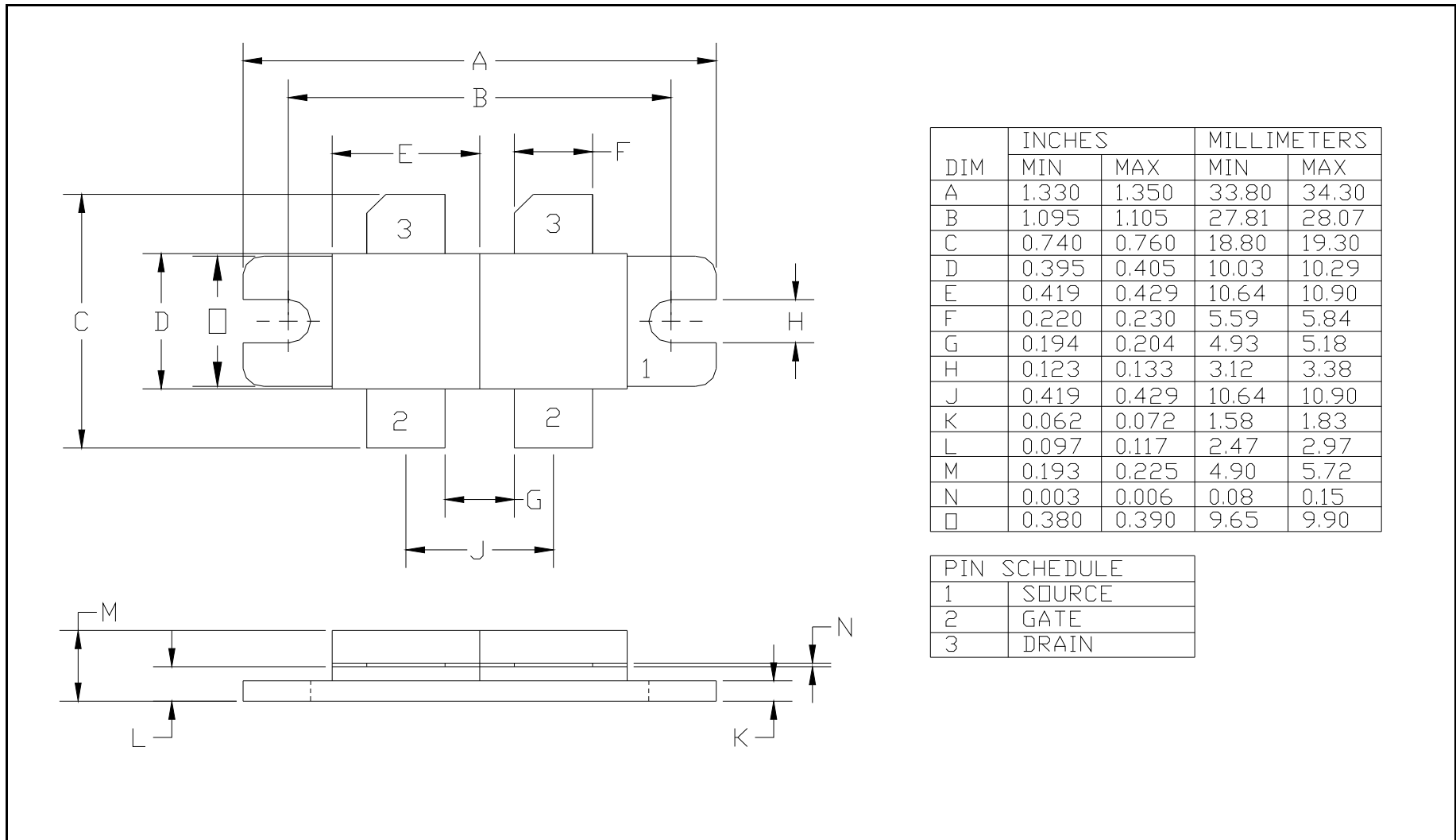

RF TEST FIXTURE (400 MHz)

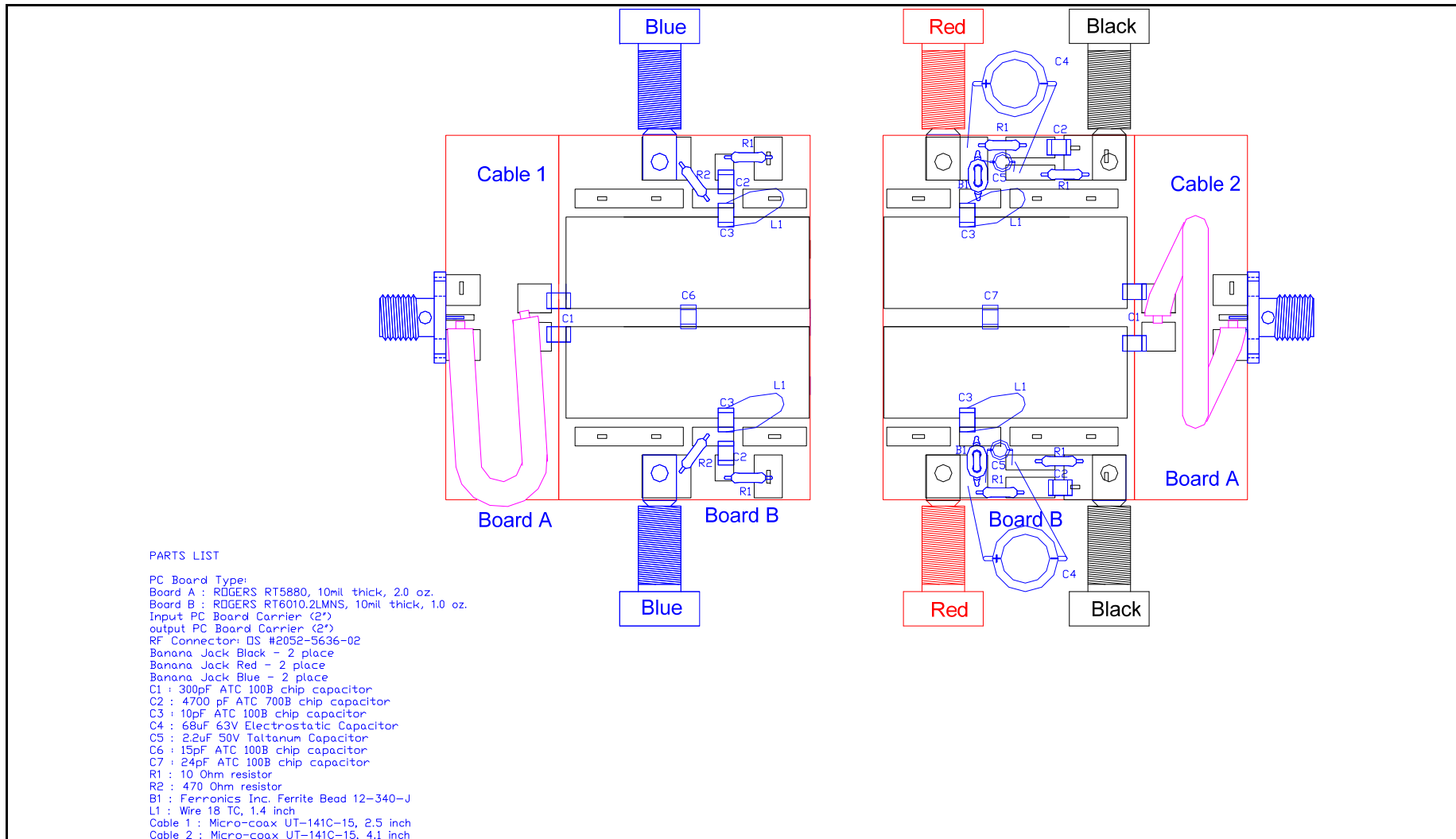

ELECTRICAL SCHEMATIC

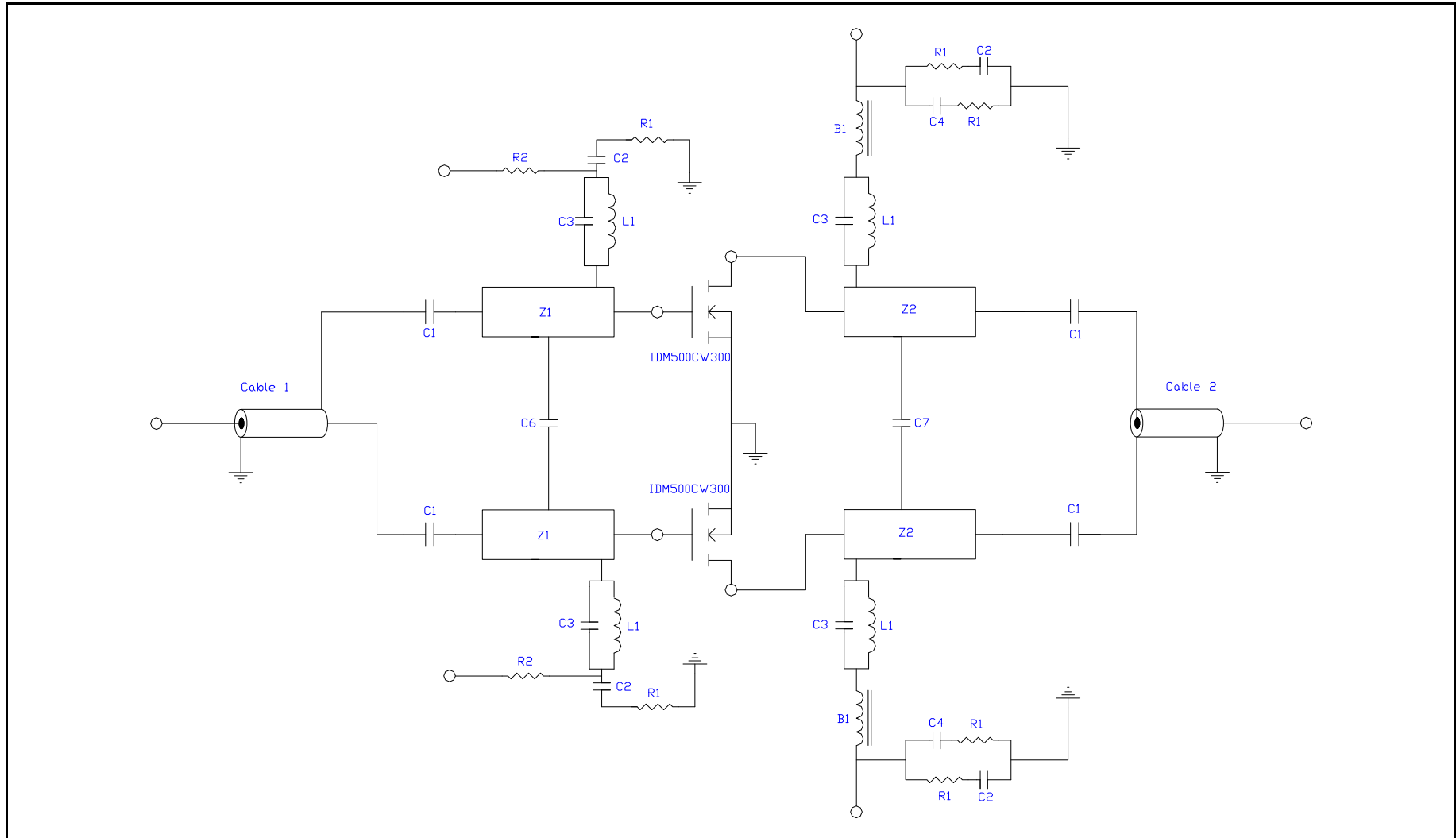

DEFINITIONS

| Data Sheet Status | |
|---|---|
| Proposed Specification | This data sheet contains proposed specifications. |
| Preliminary Specification | This data sheet contains specifications based on preliminary measurements and data. |
| Product Specification | This data sheet contains final product specifications. |
| Maximum Ratings | |
| Stress above one or more of the maximum ratings may cause permanent damage to the device. These are maximum ratings only. Operation of the device at these or at any other conditions above those given in the characteristics sections of the specification is not implied. Exposure to maximum values for extended periods of time may affect device reliability. | |

WARNING

| Product and environmental safety - toxic materials |
|--|
| This product contains beryllium oxide. The product is entirely safe provided that the BeO base is not damaged. All persons who handle, use or dispose of this product should be aware of its nature and of the necessary safety precautions. After use, dispose of as chemical or special waste according to the regulations applying at the location of the user. It must never be thrown out with general or domestic waste. |

DISCLAIMER

| |
|--|
| Integra Technologies Inc. reserves the right to make changes without further notice to any products herein. Integra Technologies Inc. makes no warranty, representation or guarantee regarding the suitability of its products for any particular purpose, nor does Integra Technologies Inc. assume any liability arising out of the application or use of any product or circuit, and specifically disclaims any and all liability, including without limitation consequential or incidental damages. Integra Technologies Inc. products are not designed for use in life support appliances, devices, or systems where malfunction of these products can reasonably be expected to result in personal injury. Integra Technologies Inc. customers using or selling these products for use in such applications do so at their own risk and agree to fully indemnify Integra Technologies Inc. for any damages resulting from such improper use or sale. |
|--|