

# L-Band, GaN/SiC, RF Power Transistor

960 - 1220 MHz | 6000 W typ | 75% Efficiency typ | 19 dB Gain typ | 125 V | 32μs Pulse Length, 4% Duty Cycle

IGN0912S5000 and IGN0912S5000S are high power GaN-on-SiC RF power transistors that have been designed to suit the unique needs of TACAN, DME and IFF/SSR avionics systems. Under 32μs, 4% duty cycle pulse conditions, they supply 5000 W of peak output power, with 18dB of associated gain and 70% efficiency. They operate from a 125 V supply voltage. For optimal thermal efficiency, the transistors are housed in a metal-based package with an epoxy-sealed ceramic lid.

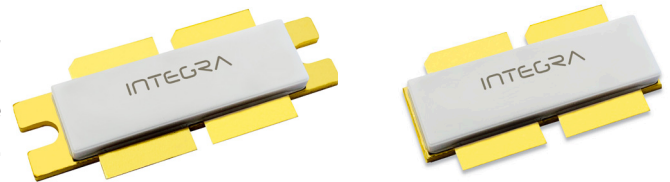

## FEATURES

- GaN on SiC HEMT Technology
- Output Power >5000 W
- Pre-matched Input Impedance
- High Efficiency - up to 75% during the RF pulse
- 100% RF Tested
- RoHS and REACH Compliant
- Full non-linear electrothermal model available, please contact the factory

## APPLICATIONS

- TACAN and DME Systems
- IFF/SSR Systems

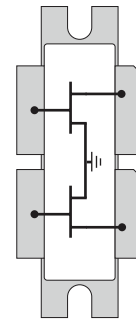

**Table 1. RF Electrical Characteristics (Case temperature = 30 °C unless otherwise stated)**

Parameter	Symbol	Min	Typ	Max	Units	Test Conditions
Gain	G	17	18	20	dB	$P_{OUT} = 5000W$ $f = 960, 1090, 1220 \text{ MHz}$ 32μs pulse length, 4% duty cycle $V_{DS} = 125V, I_{DS} = 75mA \text{ per side}$
Drain Efficiency	$\eta$	60	70	80	%	
Pulse Droop	D	-0.5	-0.3	+0.2	dB	
Input Return Loss	IRL	6	11	20	dB	
Load Mismatch Stability	VSWR-S	2:1				
VSWR Withstand	VSWR-LMT	3:1				

Note 1: Consult Integra Technologies Application Note 001 for information on how RF output power and pulse droop are measured.

**Table 2. DC Electrical Characteristics (Case temperature = 25 °C unless otherwise stated)**

Parameter	Symbol	Min	Typ	Max	Units	Test Conditions
Gate Pinch-Off Voltage	$V_p$	-5.0			V	$V_{DS} = 125V, I_{DS} = 1mA$
Quiescent Gate Voltage	$V_q$		-2.8		V	$V_{DS} = 125V, I_{DS} = 75mA \text{ per side}$

**Table 3. Absolute Maximum Ratings (Not Simultaneous)**

Parameter	Symbol	Value	Units	Test Conditions
DC Drain-Source Voltage	$V_{DS}$	400	V	25 °C
DC Gate-Source Voltage	$V_{GS}$	-8 to +1.0	V	25 °C
DC Drain Current	$I_D$	156	A	25 °C
DC Gate Current	$I_G$	156	mA	25 °C
RF Input Power	$P_{RF,IN}$	110	W	25 °C
Operating Channel Temperature	$T_J$	-55 to +225	°C	
Storage Temperature	$T_{STG}$	-55 to +150	°C	
Soldering Temperature	$T_{SOLDER}$	260 for 60s	°C	

Note: Operation outside the limits given in this table may cause permanent damage to the transistor

**Table 4. Thermal Resistance (Case temperature = 85 °C unless otherwise stated)**

Parameter	Symbol	Typ	Units	Test Conditions
Peak Thermal Resistance (total device), Channel to Case	$R_{TH}$	0.04	°C/W	$P_{diss} = 2142W$ 32µs pulse length, 4% duty cycle $V_{DS} = 125V$

**Table 5. Test Fixture One Side to Ground Source & Load Impedances (Case temperature = 25 °C unless otherwise stated)**

Frequency (MHz)	$Z_{IF}$	$Z_{OF}$	Units	Test Conditions
960	1.32 - j 1.48	2.18 - j 2.05	$\Omega$	$P_{OUT} = 5000W$ 32µs pulse length, 4% duty cycle $V_{DS} = 125V, I_{DS} = 75mA$ per side
1025	1.27 - j 0.88	2.21 - j 1.67	$\Omega$	
1090	1.23 - j 0.30	2.23 - j 1.41	$\Omega$	
1155	1.24 + j 0.29	2.24 - j 1.22	$\Omega$	
1220	1.26 + j 0.87	2.18 - j 1.10	$\Omega$	

Note: Source and load impedances are single-sided port to a 125 Ohm load impedance and are measured looking into the test fixture.

TYPICAL PERFORMANCE

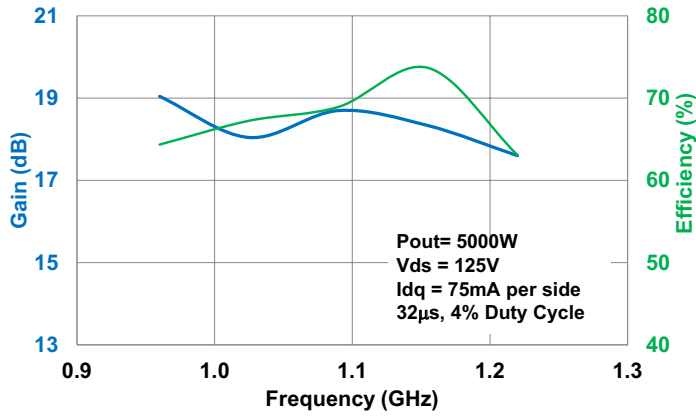

Figure 1

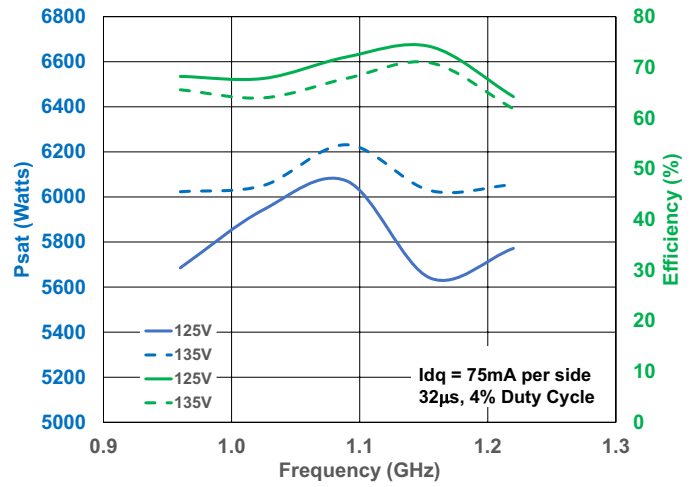

Figure 2

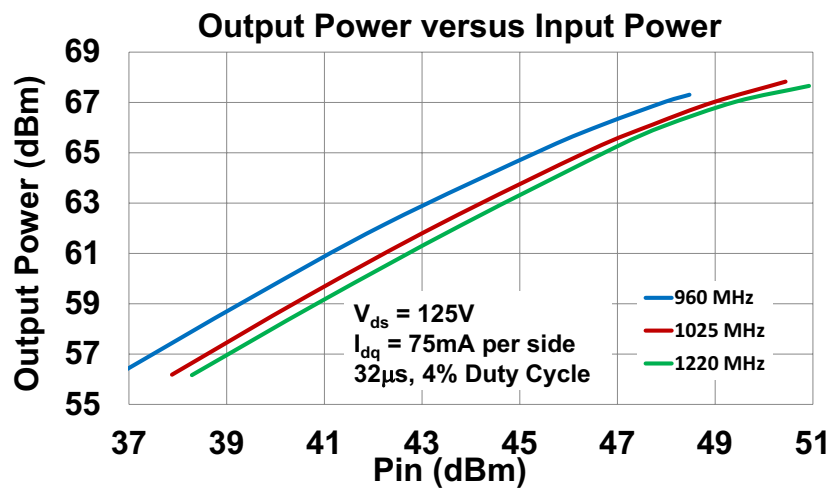
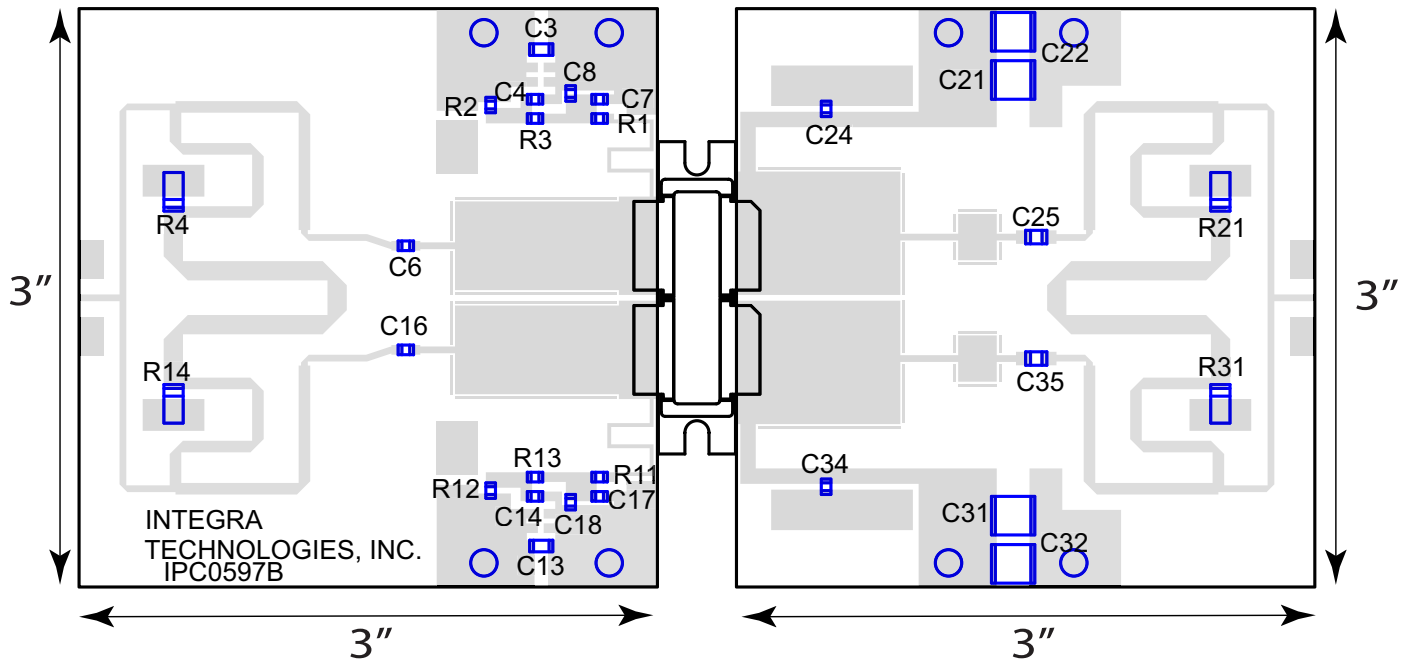

Figure 3

**TEST FIXTURE**



**Bill of Materials for IGN0912S5000 Test Fixture**

Designator	Description	Quantity	Part Number
C3, C13	CAP 1 $\mu$ F, 1206, 100V, X7R	2	12061C105K4T2A
C4, C14	CAP 0.068 $\mu$ F, 250V, 0805, X7R	2	C0805C683KARAC#A
C6, C7, C16, C17, C24, C34	CAP 33pF, 0805	6	ATC600F330
C8, C18	CAP 1000pF, 100v, 0805	2	08051A102J4T2A
C21, C22, C31, C32	CAP 2.2 $\mu$ F, 250V, 2220, X7R	4	C5750X7T2E225K250KA
C25, C35	CAP 150pF, 1111	2	800B151JT300XT
R1, R11	RES 15 OHM, 0805	2	CRCW080515R0JNEA
R2, R12	RES 100 OHM, 0805	2	CRCW0805100RFKTA
R3, R13	RES 0 OHM, 0805	2	CRCW08050000ZSTA
R4, R14, R21, R31	RES 50 OHM, 120W, 2010	4	NDC-2010SEW50R0G
PC Board Type	ROGERS RO3006, 25mil, 2/2oz. Copper	2	

**PACKAGE PL124A1**

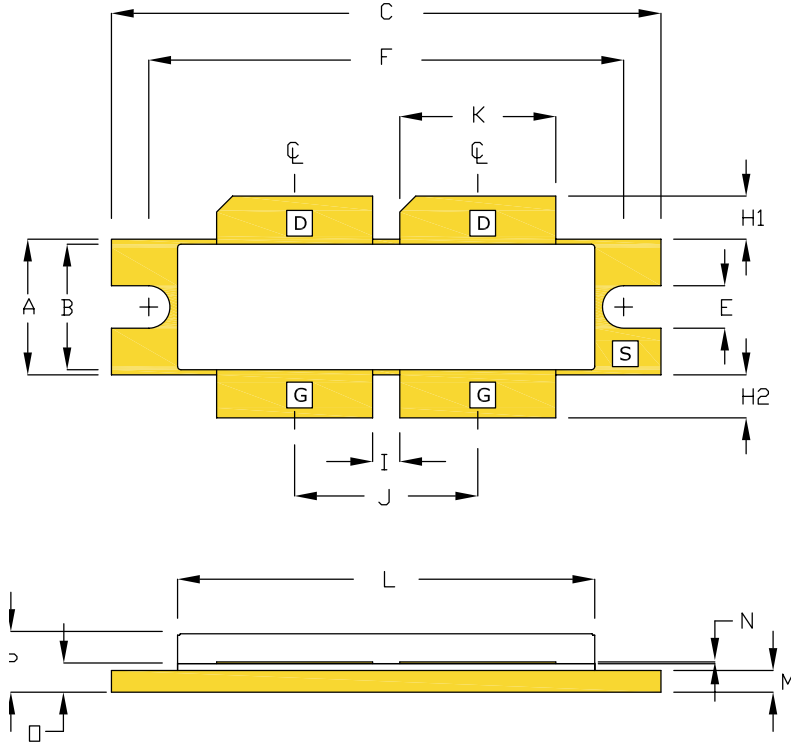

DIM	INCHES		MILLIMETERS	
	MIN	MAX	MIN	MAX
A	0.395	0.405	10.03	10.29
B	0.366	0.374	9.29	9.49
C	1.615	1.625	41.02	41.27
E	0.120	0.130	3.05	3.30
F	1.395	1.405	35.43	35.69
H1	0.120	0.130	3.05	3.30
H2	0.120	0.130	3.05	3.30
I	0.075	0.085	1.90	2.16
J	0.535	0.545	13.59	13.84
K	0.455	0.465	11.55	11.81
L	1.218	1.242	30.93	31.54
M	0.059	0.069	1.499	1.752
N	0.004	0.007	0.10	0.18
□	0.079	0.089	2.00	2.26
P	0.165	0.188	4.19	4.77

PIN SCHEDULE	
D	DRAIN
S	SOURCE
G	GATE

**BOLT-DOWN FLANGE OPTION  
IGN0912S5000**

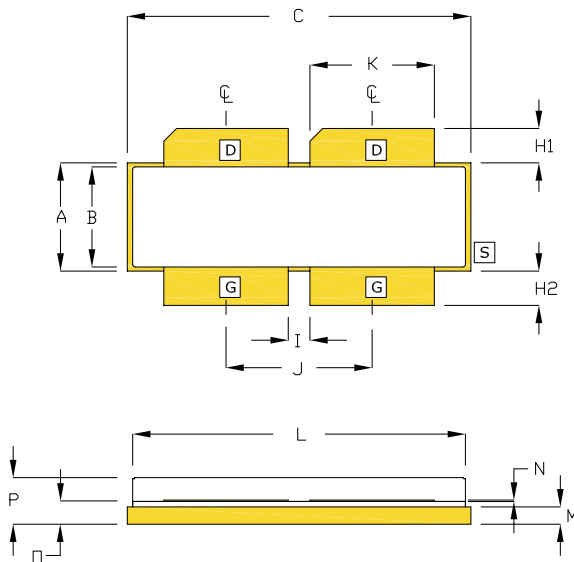

DIM	INCHES		MILLIMETERS	
	MIN	MAX	MIN	MAX
A	0.395	0.405	10.03	10.29
B	0.366	0.374	9.29	9.49
C	1.265	1.275	32.13	32.38
E	--	--	--	--
F	--	--	--	--
H1	0.120	0.130	3.05	3.30
H2	0.120	0.130	3.05	3.30
I	0.075	0.085	1.90	2.16
J	0.535	0.545	13.59	13.84
K	0.455	0.465	11.55	11.81
L	1.218	1.242	30.93	31.54
M	0.059	0.069	1.499	1.752
N	0.004	0.007	0.10	0.18
□	0.079	0.089	2.00	2.26
P	0.165	0.188	4.19	4.77

PIN SCHEDULE	
D	DRAIN
S	SOURCE
G	GATE

**EARLESS FLANGE OPTION  
IGN0912S5000S**

### ESD & MSL Rating

Parameter	Rating	Standard
ESD Human Body Model (HBM)	TBD	ESDA/JEDEC JS-001-2012
ESD Charged Device Model (CDM)	TBD	JEDEC JESD22-C101F
Moisture Sensitivity Level (MSL)	Unlimited Shelf Life	IPC/JEDEC J-STD-020

### RoHS Compliance

Integra Technologies, Inc declares that its GaN and LDMOS Transistor Products comply with EU Directive 2011/65/EU on the restriction of the use of certain hazardous substances in electrical and electronic equipment (RoHS2), as adopted by EU member states on January 2, 2013 and amended on March 31, 2015 by EU Directive 2015/863/EU.

### REACH Compliance

Integra Technologies supports EU Regulation number 1907/2006 concerning the Registration, Evaluation, Authorization, and Restriction of Chemicals (REACH) as these apply to Integra semiconductor products, development tools, and shipping packaging.

In support of the REACH regulation, Integra will:

- Inform customers and recipients of Integra product if they contain any substances that are of very high concern (SVHC) per the European Chemical Agency (ECHA) website.
- Notify ECHA if any Integra product that contains any SVHCs which exceed guidelines for REACH chemicals by weight per part number and for total content weight per year for all products produced in or imported to the European market.
- Cease shipments of product containing REACH Annex XIV substances until authorization has been obtained.
- Cease shipment of product containing REACH Annex XVII chemicals when restrictions apply.

Integra has evaluated its materials, BOMs, and product specifications and product and has determined that this transistor conforms to all REACH and SVHC regulations and guidelines. Integra has implemented actions and control programs that will assure continued compliance.

### Disclaimer

Integra Technologies Inc. reserves the right to make changes without further notice to any products herein. Integra Technologies Inc. makes no warranty, representation or guarantee regarding the suitability of its products for any particular purpose, nor does Integra Technologies Inc. assume any liability arising out of the application or use of any product or circuit, and specifically disclaims any and all liability, including without limitation consequential or incidental damages. Integra Technologies Inc. products are not designed for use in life support appliances, devices, or systems where malfunction of these products can reasonably be expected to result in personal injury. Integra Technologies Inc. customers using or selling these products for use in such applications do so at their own risk and agree to fully indemnify Integra Technologies Inc. for any damages resulting from such improper use or sale.

#### DEFINITIONS:

#### DATA SHEET STATUS

Advanced Specification - This data sheet contains Advanced specifications.

Preliminary Specification - This data sheet contains specifications based on preliminary measurements and data.

Final Specification - This data sheet contains final product specifications.

**MAXIMUM RATINGS** Stress above one or more of the maximum ratings may cause permanent damage to the device. These are maximum ratings only operation of the device at these or at any other conditions above those given in the characteristics sections of the specification is not implied. Exposure to maximum values for extended periods of time may affect device reliability.