

L-Band, GaN/SiC, RF Power Transistor

1.2 - 1.4 GHz | 2000 W typ | 70 % Efficiency typ | 17 dB Gain typ | 100 V | 100µs Pulse Length, 10% Duty Cycle

IGN1214M1600 and IGN1214M1600S are high power GaN-on-SiC RF power transistors that have been designed to suit the unique needs of modern long-range radar systems. They supply a minimum of 1600 W of peak output power, with typically >17 dB of associated gain and 65% efficiency. They operate from a 100 V supply voltage. For optimal thermal efficiency, the transistors are housed in a metal-based package with an epoxy-sealed ceramic lid.



FEATURES

- GaN on SiC HEMT Technology
- Output Power >1600 W
- Pre-matched Input Impedance
- High Efficiency - up to 70%
- 100% RF Tested under 100µs, 10% duty cycle pulse conditions
- RoHS and REACH Compliant
- Full non-linear electrothermal model available, please contact the factory

APPLICATIONS

- L-band Radar Systems

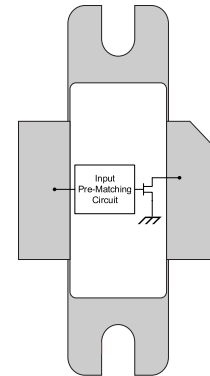

Table 1. RF Electrical Characteristics (Case temperature = 30 °C unless otherwise stated)

Parameter	Symbol	Min	Typ	Max	Units	Test Conditions
Gain	G	16	17	18	dB	$P_{OUT} = 1600W$ $f = 1.2, 1.3, 1.4 \text{ GHz}$ 100µs pulse length 10% duty cycle pulse conditions $V_{DS} = 100V, I_{DS} = 75mA$
Drain Efficiency	η	60	65	75	%	
Pulse Droop	D	-0.5	-0.35	+0.2	dB	
Input Return Loss	IRL	10	15	20	dB	
Load Mismatch Stability	VSWR-S	2:1				
VSWR Withstand	VSWR-LMT	5:1				
Second Harmonic			-25		dBc	
Third Harmonic			-40		dBc	
Typical Gain Variation with Temperature			-0.015		dB/°C	

Note: Consult Integra Technologies Application Note 001 for information on how RF output power and pulse droop are measured.

Table 2. DC Electrical Characteristics (Case temperature = 25 °C unless otherwise stated)

Parameter	Symbol	Min	Typ	Max	Units	Test Conditions
Gate Pinch-Off Voltage	V_p	-5.0			V	$V_{DS} = 100V, I_{DS} = 1mA$
Quiescent Gate Voltage	V_q		-2.8		V	$V_{DS} = 100V, I_{DS} = 75mA$

Table 3. Absolute Maximum Ratings (Not Simultaneous)

Parameter	Symbol	Value	Units	Test Conditions
DC Drain-Source Voltage	V_{DS}	400	V	25 °C
DC Gate-Source Voltage	V_{GS}	-8 to +1	V	25 °C
DC Drain Current	I_D	78	A	25 °C
DC Gate Current	I_G	78	mA	25 °C
RF Input Power	$P_{RF,IN}$	40	W	25 °C
Operating Channel Temperature	T_{CH}	-55 to +225	°C	
Storage Temperature	T_{STG}	-55 to +150	°C	
Soldering Temperature	T_{SOLDER}	260 for 60s	°C	

Note: Operation outside the limits given in this table may cause permanent damage to the transistorS

Table 4. Thermal Resistance (Case temperature = 85 °C unless otherwise stated)

Parameter	Symbol	Typ	Units	Test Conditions
Peak Thermal Resistance Channel to Case	R_{TH}	0.13	°C/W	$P_{Diss} = 862W$ 100µs pulse length, 10% duty cycle $V_{DS} = 100V$

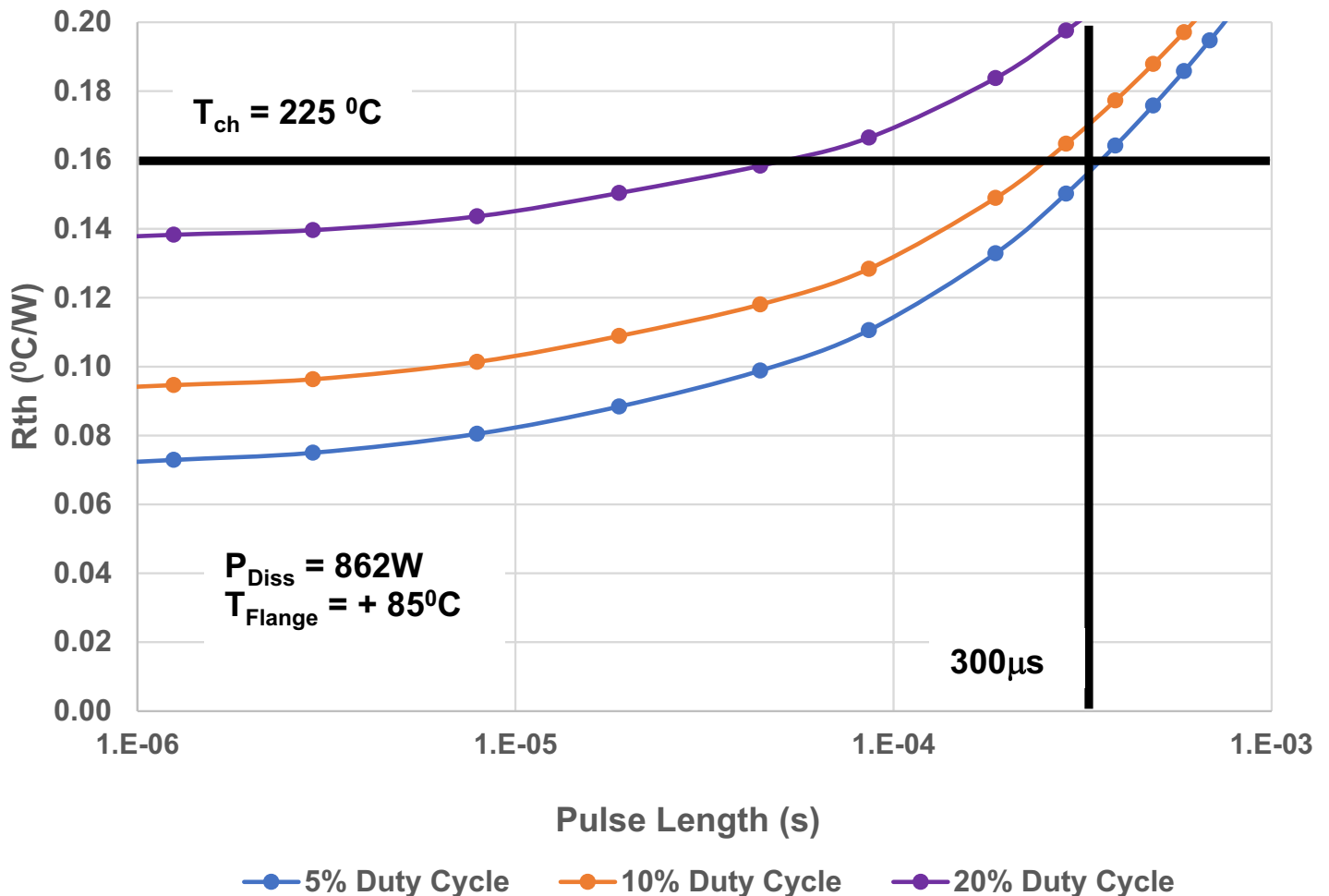
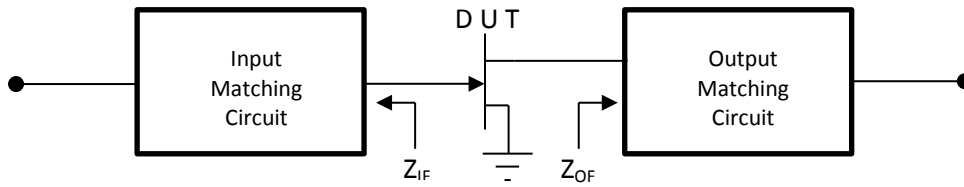

Table 5. Test Fixture Source & Load Impedances (Case temperature = 25 °C unless otherwise stated)

Frequency (GHz)	Z_{IF}	Z_{OF} Fundamental	Z_{OF} Second Harmonic	Units	Test Conditions
1.2	1.25 - j 1.48	2.18 - j 2.87	1.08 + j 1.65	Ω	$P_{OUT} = 1600W$ 100 μs pulse length, 10% duty cycle $V_{DS} = 100V, I_{DS} = 75mA$
1.3	1.16 - j 0.64	2.09 - j 2.70	0.99 + j 3.58	Ω	
1.4	1.11 + j 0.14	2.06 - j 1.67	1.51 + j 5.02	Ω	



TYPICAL PERFORMANCE

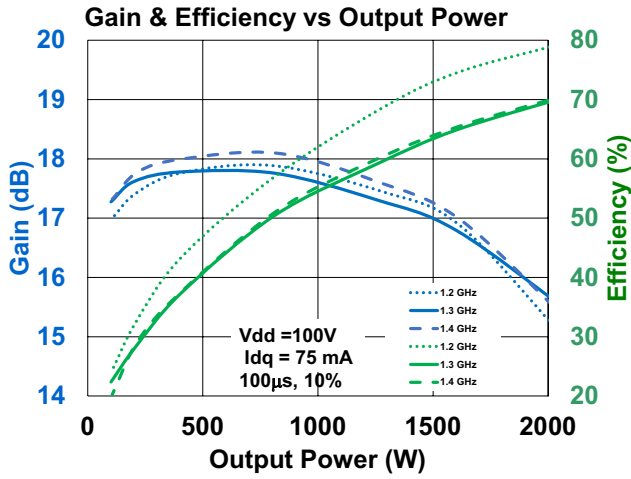

Figure 1.

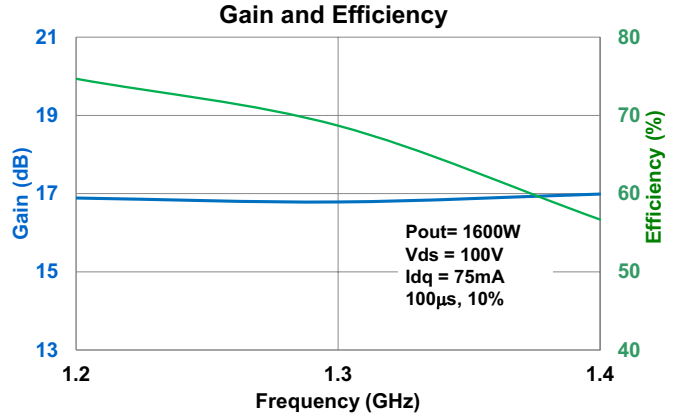

Figure 2.

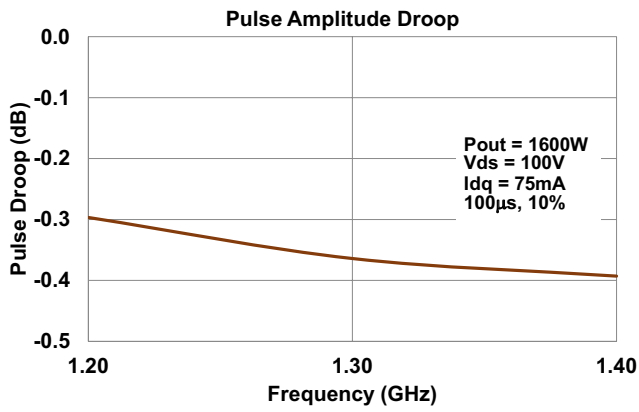

Figure 3.

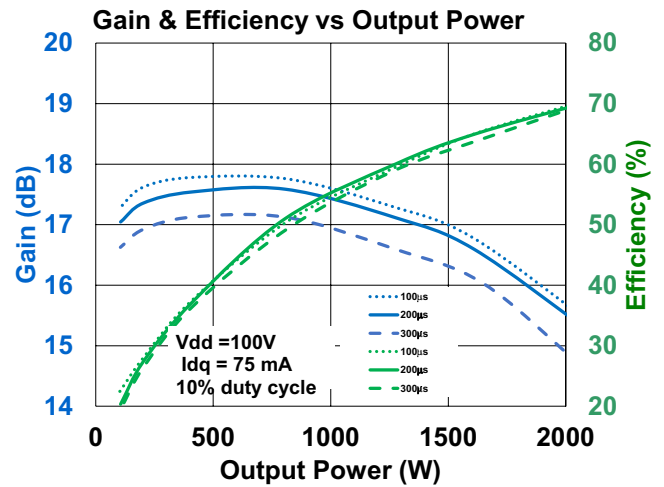
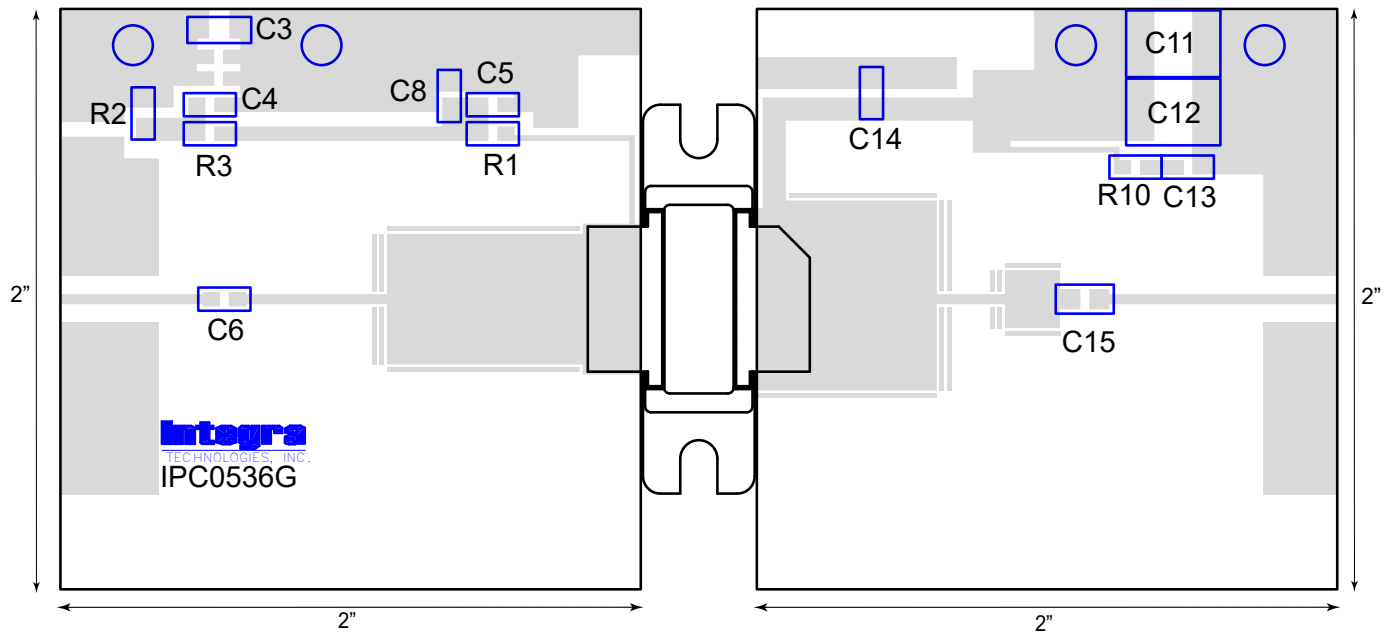

Figure 4

TEST FIXTURE



Bill of Materials for IGN1214M1600 Test Fixture

Designator	Description	Part Number
C3	CAP 1 μ F, 1206, 100V , X7R	12061C105K4T2A
C4, C13	CAP 0.068 μ F, 0805, 250V, X7R	C0805C683KARAC#A
C5, C6, C14	CAP 33pF, 0805, 100V	ATC600F330
C8	CAP 1000pF, 0805, 100V	08051A102J4T2A
C11, C12	CAP 2.2 μ F, 2220, 200V, X7R	22202C225KAT2A
C15	CAP 150pF, 1111	ATC800B
R1, R10	RES 15 Ω , 0805	CRCW080515R0JNEA
R2	RES 100 Ω , 0805	CRCW0805100RFKTA
R3	RES 0 Ω , 0805	CRCW08050000ZSTA
PC Board	ROGERS RO3006 25mil, 2/2oz. Copper	

PACKAGE PL84A1

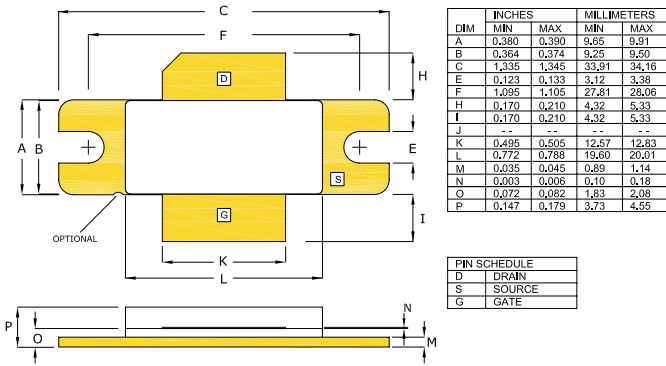

BOLT-DOWN FLANGE OPTION
IGN1214M1600

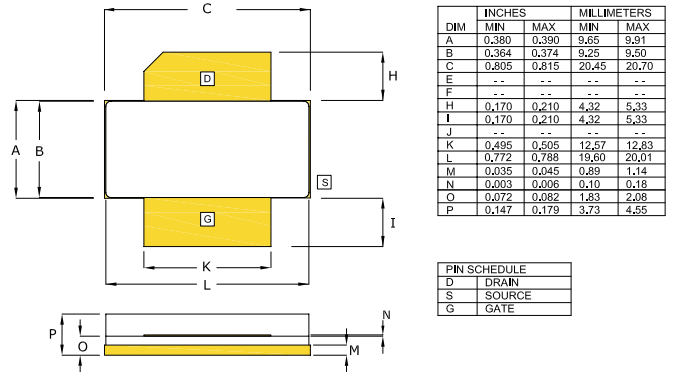

EARLESS FLANGE OPTION
IGN1214M1600S

ESD & MSL Rating

Parameter	Rating	Standard
ESD Human Body Model (HBM)	TBD	ESDA/JEDEC JS-001-2012
ESD Charged Device Model (CDM)	TBD	JEDEC JESD22-C101F
Moisture Sensitivity Level (MSL)	Unlimited Shelf Life	IPC/JEDEC J-STD-020

RoHS Compliance

Integra Technologies, Inc declares that its GaN and LDMOS Transistor Products comply with EU Directive 2011/65/EU on the restriction of the use of certain hazardous substances in electrical and electronic equipment (RoHS2), as adopted by EU member states on January 2, 2013 and amended on March 31, 2015 by EU Directive 2015/863/EU.

REACH Compliance

Integra Technologies supports EU Regulation number 1907/2006 concerning the Registration, Evaluation, Authorization, and Restriction of Chemicals (REACH) as these apply to Integra semiconductor products, development tools, and shipping packaging.

In support of the REACH regulation, Integra will:

- Inform customers and recipients of Integra product if they contain any substances that are of very high concern (SVHC) per the European Chemical Agency (ECHA) website.
- Notify ECHA if any Integra product that contains any SVHCs which exceed guidelines for REACH chemicals by weight per part number and for total content weight per year for all products produced in or imported to the European market.
- Cease shipments of product containing REACH Annex XIV substances until authorization has been obtained.
- Cease shipment of product containing REACH Annex XVII chemicals when restrictions apply.

Integra has evaluated its materials, BOMs, and product specifications and product and has determined that this transistor conforms to all REACH and SVHC regulations and guidelines. Integra has implemented actions and control programs that will assure continued compliance.

Disclaimer

Integra Technologies Inc. reserves the right to make changes without further notice to any products herein. Integra Technologies Inc. makes no warranty, representation or guarantee regarding the suitability of its products for any particular purpose, nor does Integra Technologies Inc. assume any liability arising out of the application or use of any product or circuit, and specifically disclaims any and all liability, including without limitation consequential or incidental damages. Integra Technologies Inc. products are not designed for use in life support appliances, devices, or systems where malfunction of these products can reasonably be expected to result in personal injury. Integra Technologies Inc. customers using or selling these products for use in such applications do so at their own risk and agree to fully indemnify Integra Technologies Inc. for any damages resulting from such improper use or sale.

DEFINITIONS:

DATA SHEET STATUS

Advanced Specification - This data sheet contains Advanced specifications.

Preliminary Specification - This data sheet contains specifications based on preliminary measurements and data.

Final Specification - This data sheet contains final product specifications.

MAXIMUM RATINGS Stress above one or more of the maximum ratings may cause permanent damage to the device. These are maximum ratings only operation of the device at these or at any other conditions above those given in the characteristics sections of the specification is not implied. Exposure to maximum values for extended periods of time may affect device reliability.